

**UNI-MIG**  
**WELDING**



# WORKSHOP 255

*Compact MIG Manual*





# 3 YEARS Warranty\*

## Machine Model

Description	Part Number
UNIMIG Workshop 255	KUM255

## CONTENTS PAGE No:

Safety	4
General Description	6
Operation	7
Parts List	9
Machine Parts	11
Welding Tips	12
Maintenance	14
Trouble Shooting	14

### \*\*\* CAUTION \*\*\*

Do not heat, cut or weld tanks, drums or containers until the proper steps have been taken to insure that such procedures will not cause flammable or toxic vapours from substance inside. These can cause an explosion even though the vessel has been "cleaned". Vent hollow castings or containers before heating, cutting or welding. They may explode.

## CE Declaration



The manufacturer: Weld-Impex Manufacturing and Trading Ltd. declares that the product conforms to

- o EN 60974-1 (Arc welding equipment)
- o EN 50199 (Electromagn. compatibility)
- o EN ISO 12100-2 (Safety of machinery)
- o 73/23 EGK (Low-voltage directives)
- o 89/336 EGK (Electromagn. compatibility)
- o 98/37 EK (Machines)

European directives, norms and is suitable for the technical parameters in the instruction manual.

The machine has been designed according to the European norm EN 60974-1, it fulfils the (*disturbance filtering*) directions of EN 55011:1994 group "A", and it also complies with the directions of the European directive 2002/95/CE (RoHS).

Karcag, Febr. 12, 2007.

.....  
István KISS  
Managing Director

## Legal Declaration

The quality certification will be handed over to the customer when purchasing. *Technical* parameters and *proper* usefulness of the equipment are warranted by the producer.

Warranty begins at installation; its period and services' list are in the *warranty* (supplement).

The manufacturer doesn't take responsibility for damages resulting any of the followings:

- o using *not according* to intended designation
- o *not complying* with labour etc. safety instructions
- o *not knowing* instruction manual
- o *not proper qualification* for the specified work (installation, welding, maintenance, etc.)
- o *lending* the machine without instruction manual, and/or to *not well* trained person.

The manufacturer reserves the rights to change *properties*, *technical parameters*, *appearance* of the product.

Built-in parts *lose* their warranty if damaged!

This Manual is under *copyright* owned by Weld-Impex Ltd. Without preliminary written permission, it is prohibited to *distribute*, *copy*, or using by *other way* any data (text, figure).

*All right reserved.* © Weld-Impex Ltd. 2007.

Weld-Impex Ltd. has the Quality Management System certified by ISO-9001. Its number: HU97/10906.



## Information:

- o Address:  
Weld-Impex Ltd. 5300 Karcag, Kunhegyesi út 2.  
(from Karcag towards *Kunmadaras*, out of the town.)
- o Internet: [www.weldimpex.com](http://www.weldimpex.com)  
*Hungarian:* [www.weldimpex.hu](http://www.weldimpex.hu)
- o E-mail:  
[weldiker@weldimpex.hu](mailto:weldiker@weldimpex.hu) (*trade*)  
[muszak@weldimpex.hu](mailto:muszak@weldimpex.hu) (*technical support*)
- o Telephone:
  - o (+36) 59 **500-241**: *General office (director)*
  - o (+36) 59 **500-244**: *Trading office*
  - o (+36) 59 **503-515**: Telex

## Our other services:

- o Galvanization, electrostatic powder-painting
- o Screen process
- o Body ironing works (also CNC)
- o Manufacture of dry transformers
- o Manufacture of *unique* electrical equipments
- o Repairs *over* the guarantee
- o Technical supervision
- o Installing, transport, commission
- o *Leasing* of equipment (MIG, TIG, Plas)
- o *National* service network

For details, please visit our website or ask for information by telephone!

# SAFETY

## SAFETY PRECAUTIONS

for electric machines of welding/cutting industry



**Present Manual should be studied thoroughly before starting any operation!**



Next paragraphs provide some **safety precautions** and **instructions** how to use electric machines of *welding* and *cutting* industry in order **all persons** to **prevent** accidents, injuries etc.

As all preventing rules cannot be written because of **many variations** of **task environment**, **follow** the rules concerning the actual job(s) and the employer's **safety practices**.

**Read, understand** and **keep industrial safety** and **fire protection** instructions concerning to **safety of all parts** and **equipments** used (cylinder, torch, extractor, etc.).

### 1. Dangerous features



1. Formed **conditions** of the machine and work are important: **transport, storage, installation, operation, maintenance**.
2. The machine is connected to the **mains network**.
3. The **electrode, work-piece** (or *ground*), and **cables** are **under voltage** (electrically live). Voltage of more electrodes can be **added up** on the work-piece. At **plasma cutting** there is 200–350 V at the torch!

At *welding/cutting*, the followings are **produced**:

4. Visible **light**, ultraviolet and infra-red **rays**, significant **heat**.
5. **Sparks, spatter** and high-energy **metal drops** with **great temperature** (800–1600 °C). These are thrown from the arc and can **fly** to **adjacent** areas (through small gaps).
6. Toxic **fumes, gases** and **smoke** generated from
  - the **worked** (e.g. galvanized, lead or cadmium plated) metal,
  - the gas used **for work**,
  - those reacting with **each other** (e.g. phosgene).
7. Considerable **electromagnetic field** (because of high-current *arc* and *mains cable*) that **radiates** to the environment. Its effect **highly** decreases with the distance. Radiation of machines with **HF-ignition unit** (TIG, Plas) is **more** bigger.
8. **Cylinders** using for work and **nearby** contain **high-pressure gas**.

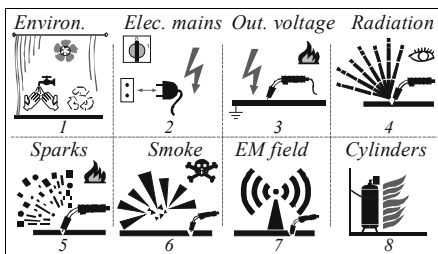

### 2. Damaging effects

These **dangerous features** have **harmful** influence to the **workers** and also to **near living beings, machine**, and **other equipments**:

#### ◆ General injuries

1: A not suitable made **environment**, a not well prepared and made **working area** can be **dangerous** (machine tipping over, its overheating, person falling down, etc.).



#### ◆ Electric shock

2: The machine's **inside** is **under mains voltage**.

3: Machine's **cables** have **voltage** while working.



#### ◆ Eye damaging

4: *Arc ray* causes **eye inflammation**.

5: *Flying sparks* can cause **physical** eye damaging.

6: *Smoke, gas, fume* can **irritate** the eye.

8: *Cylinders' overpressure* can come to the eye.



#### ◆ Hand and skin injuries

4: **Heat effect** of the *arc ray* and the overheated **work-piece** can burn the skin.

5: *Flying sparks* can reach the skin.

6: *Smoke, gas, fume* can **irritate** the skin.



#### ◆ Breathing damage

6: *Smoke* etc. can **displace** air and **breathing in** can cause injury or even death.



#### ◆ Fire and explosion danger

2: *Electric fault* can happen in the machine in principle.

3: *Cables* can **overheat** or a **short-circuit** can happen.

4: *Arc ray* has a **great heat effect** to the work-piece.

5: *Sparks* are of **high** temperature and **fly far away**.

6: *Fumes* can be **hot** and can stimulate burning.

8: *Cylinders* can contain **high-pressure** and **fire-feeding** gas (e.g. oxygen).



#### ◆ Electromagnetic disturbances

7: *EM radiation* has **too much** energy for **sensitive** electrical equipments.



#### ◆ Environmental damage

1,4,5,6: *Welding/cutting* and its **waste materials** can **contaminate** the surrounding **soil, waters, and air**. **Damaging noise, light, and heat** are produced.

### 3. The machine's transport, storage



- » Must be in **upright** position, secured against tipping over.
- » **Lifted** (if **bigger** size) by means of lift device and with the help of **more** personnel.
- » **Protected** against vapour, moisture, **damaging** weather and mechanical effects (in **dry, covered** place, for good cause in its box or covered).



### 4. Creating working area





- » The **working area** should be ...
  - clean and **orderly**
  - well-**lighted** and -aired (e.g. extractor fan), and of good temperature; **protected** from falling water, rain, and storm
  - of straight, smooth floor, **free from obstructions** (of non-combustible material)
  - screened, fenced off with **safety grids** (if necessary).



# SAFETY

» In the *working area* or near, there not be ...

- *inflammable* materials (or cover them)  
- person living with pacemaker
- electrically sensitive appliances in the area of health (e.g. pacemaker), control (e.g. computer), measurement, safety (e.g. guard), radio-waves (e.g. mobile phone), etc.

» The cylinder ...

- must be in upright position, securely chained to a fixed support, and away from areas where they may be subjected to damaging physical or heat effect
- valve protection cap should always be in its *place* if out of use.

» Pay attention to the followings:

- Keep a fire-extinguisher, water hose, blanket, etc. readily available for immediate use.
- Connect work clamp to the work piece close to the working area (not be complex current path). Connections must be tight.
- Ground the work to a good electrical point.
- Place the high-current cables side by side and at floor. Nobody stay close to them for a long time.
- Cables not be wound around metal or living body.

## 5. Operation



» The equipment:

- can be operated at a place which is suitable for safety work and well ventilated
- changes decreasing its safety shall not be carried out
- its electric shock prevention test must be carried out regularly as prescribed
- must be connected to a line provided with protective grounding, circuit breaker or fuse, and possibly protection switch
- its airing grids/slots be free
- can be used only for the purpose that it was designed for
- its all installation, repair and maintenance works (possibly on disconnected machine) can be performed only by qualified, trained, and competent (examined) persons, according to the labour safety provisions, electric shock protection, and local and manufacturer's regulations.

» Protect ...







- cables from any kind of damage, e.g. don't step on them and don't roll anything over them
- low-current cables of the machine(s) by laying them in a safe location, or, if necessary, with screening
- public utilities (gas hoses and fittings, electric wires and equipments, etc.)
- air (by filter usage), soil, worked metal etc. from contamination.

## 6. Working







» Don't weld/cut ...

- with covers removed or with damaged cables
- materials and parts under voltage (also don't touch these)

- near to inflammable or explosive materials, dust, vapours (e.g. chlorinated hydrocarbon vapours coming from cleaning or spraying operations)
- when not knowing what gases and fumes can be generated e.g. from coated metals   
- in damp and dirty environment   
- tanks, drums, barrels, cylinders, containers, etc. as these are filled up with vapours (being inside in spite of "cleaning" and produced by working).

» Pay attention to the followings:

- Safe and stable working position is needed.
- Rolls of wire feeder and the fed wire are dangerous (at MIG welding).
- Use enough ventilation and mask or respirator.
- Keep your head and face:
  - ♦ out of the fume (avoid breathing in these)  
  - ♦ away from the valve outlet when opening it.
- Wear protective clothing (isolate yourself from the work-piece):
  - ♦ oil-free, fire-resistant clothing covering all body 
  - ♦ dry, leather gloves with no holes
  - ♦ high shoes, hair cap, ear plugs  
  - ♦ safety filter glass with side shield (helmet).
- Switch off the machine when out of use (wait its cooling; also recommended pulling the mains plug out).
- Waste materials must be handled carefully, regularly.
- Keep all parts, fittings (e.g. gas hose) in well and safety condition, suitable for work, according to rules and specifications.

» Don't do the followings:

- Don't turn any switch, don't pull cables from the connector while working.
- Never turn the torch toward anybody (and yourself).
- Don't touch the electrode:
  - ♦ to the work-piece when this is not necessary
  - ♦ to parts or cylinder under voltage
  - ♦ if touching also the work-piece at the same time
  - ♦ to liquid (e.g. for cooling).

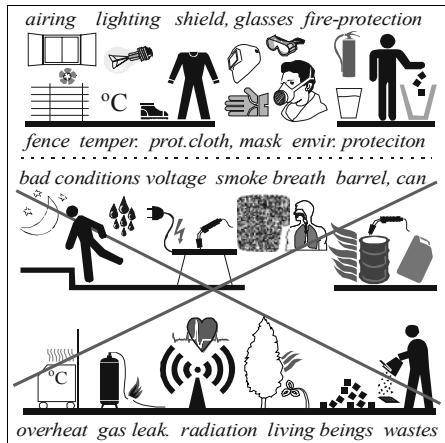

## 1. Introduction

In case of MIG/MAG welding method the arc is generated between the automatically fed *welding wire* and the *working piece*, shielding in CO<sub>2</sub> gas or gas mixture.

The machine is able to weld unalloyed and low alloyed *steel plates*. When welding thin car chassis, the application of *gas mixture* is recommended, whilst in other cases, when deep penetration is required, *pure CO<sub>2</sub>* renders better solution.

Important advantages of this technology are high *heat concentration* and *current density* so warp of the material is very low.

Additional advantages:

- ◆ high welding speed, quick melting,
- ◆ deep penetration, high melting rate,
- ◆ ability to weld thin plates, roots, etc.,
- ◆ wide range of welding parameters,
- ◆ easy automation,
- ◆ no slag on the welded seam.

The one-station MIG/MAG arc welding equipment has a *flat static characteristic*. It is designed to constitute a compact unit with the *gas bottle* and the *undercarriage* fixed to it.

Main parts of the machine:

- ◆ Metal housing with wheels and fan
- ◆ Wire feeding unit with motor
- ◆ Main transformer (of flat static characteristic)
- ◆ Rectifier bridge
- ◆ Choke&capacitors for smoothing the welding current
- ◆ Auxiliary transformer
- ◆ Contactor and solenoid (gas) valve
- ◆ Electronic control unit

## 2. Specification

Mains voltage	240 V, 50 Hz	Number of welding steps	21 (3×7)
Nominal input power	8.2 kVA	Class of heat resistance	F
Maximum input current	50 A	Cooling	AF
Input fuse	T 35 A	Insulation class	I
Open circuit voltage (DC)	18 - 49 V	Protection class	IP 21
Welding current range	30 A - 250 A	Weight (approx.)	111 kg
Duty cycle	40% - 250 A, 60% - 200 A 100% - 170 A	Dimensions (w×h×l) without wheels	460×870×940 mm 340×740×940 mm

## 3. Transport and storage

The manufacturer delivers the equipment with standard *accessories* and *undercarriage* mounted. Before transport, the machine has to be secured against tipping over and protected against adverse effects of the weather.

It must be stored at dry, covered places. Protect it against moisture and mechanical shock carefully!

## 4. Installation

The equipment must be operated at places providing all the necessary conditions for its *safe operation*.

The machine should be connected to a line provided with protective **grounding**, fuse and differential protection switch. Always comply with the *provisions of standards* when repairing and installing the equipment.

◆ Open the right-side cover. The **reel holder** is placed in a room separated from the electric parts and is mounted to the separating wall.

Push the *wire reel* onto the holder. Make free the end of the wire and cut it *smoothly*.

The reel's *braking* can be adjusted by the *bolt* located on the middle of the holder, after removing the *nut* which fixes the reel.

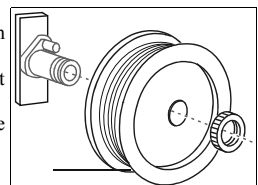

◆ The **wire feeding mechanism** which is mounted electrically isolated from the body serves for the **reliable** feed of the welding wire. The **shaft** of the feeding motor is equipped with a **drive (or feeding) roll**, the **groove** of which aligns the welding wire.

The wire is pressed against the drive roll by a free running **bearing roll** pressed down by the **pressure arm**. The pressure on the driving roll can be adjusted by a **screw**. The wire is guided by a **guiding spiral**.

The feeding roll, marked at its outer surface has **two** grooves. In case of changing the wire, remove shaft nut and **turn** the feeding roll.

**Unlock** the pressure arm and **align** the wire into the groove of the drive roll putting a short part of the wire into the **central adaptor**. Finally, **put the cover back**, to **protect** the wire reel and the feeding unit against contamination.

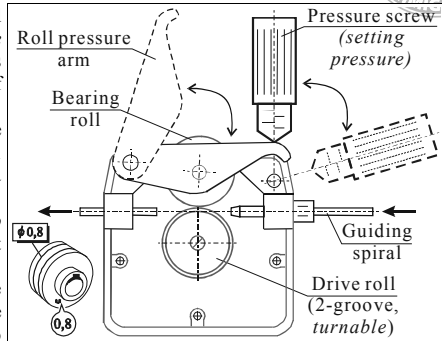

◆ **Equip** the **gas bottle** with **pressure regulator** and **flow meter** according to the instruction manuals.

**Put** the gas bottle onto the equipment, **secure** it by the chain **carefully** and mount the flare nut of the gas hose to the regulator output by a wrench.

Leakage should be **checked** at both ends e.g. by soap-water.

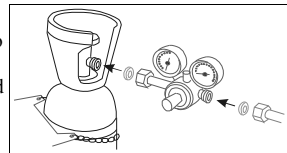

◆ **Connect** the ...

- **earth clamp** to the work piece or bench,
- **torch** to the **central adaptor**,
- short **polarity cable** to an **output socket** (generally to '+'),
- **earth cable** to another socket (according to the less spatter).

The **gas hose** (to the cylinder) and **mains cable** are located at the rear plate; **fuses** are on the inside separating wall.

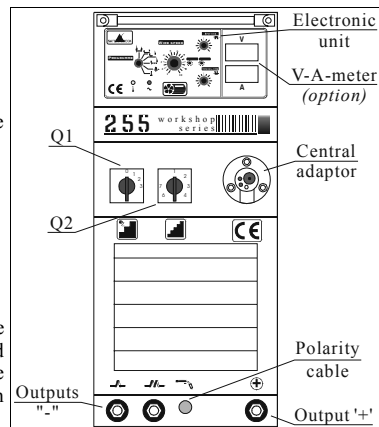

## 5. Operation

- Q1: Main and coarse setting switch (0-1-2-3)
- Q2: Fine setting switch (1-2-...-7)

**Thermo-switches** wound onto the main transformer prevent the machine from overheating, in this case the welding voltage and wire feeding are **switched off**. After the built-in fan **cools** the equipment down (through the vent-holes by air flow), welding can be continued.

The machine is controlled by an **electronic unit** which provides the feeding motor's DC voltage, switches the **contactor** and **gas valve** on/off and controls the welding process.

- Green LED: signals the machine's on.
- Yellow LED: signals the overheating.
- K: Function selector switch.
- P4: Wire feed speed potentiometer.
- P7: Welding **on** time potentiometer.
- P8: Welding **off** time potentiometer.
- P1: Wire burn back time (mini) potentiometer.
- P2: Gas post-flow time (mini) potentiometer.

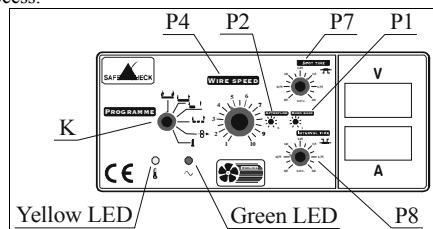

Two operation modes which can be chosen by the **function selector switch (K)** are:

» **Wire threading:** While **pushing** the torch button, the feeder is **feeding** the wire with speed approx. 10 m/min. into the torch cable (any other functions are prohibited). For smooth wire feed, keep torch cable as **straight** as possible during this. In case of **slippage** of the wire, increase drive roll pressure by the set screw.

- » **Gas test:** While *pushing* the torch button, the gas valve is *open* (any other functions are prohibited). During this time the quantity and the pressure of gas can be checked and set. Set gas flow between approx. 10-16 l/min (*depending* on the welding current).

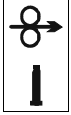

The welding can be started by pushing the button on the welding torch:

- First there is only *gas pre-flow* (its duration can be 0-0.5 sec., setting by P3 potentiometer on the PCB);
- Afterwards the *wire feeding* begins, with soft start (its duration is set to 0.2 sec. by P9 on PCB), and also the *welding current* starts.

The welding work is according to the operation modes set by the function selector switch (K):

- » **4-stroke mode:** Releasing the button the welding *continues* and it stops only if the button is pushed again.
- » **2-stroke mode:** After releasing the button, the welding *stops*.
- » **Spot welding:** After the set time is finished (or releasing the button), the welding stops. The duration of the spot welding can be set by P7 potentiometer (0.5-2.5 sec).
- » **Interval welding:** The welding stops if the button is *released* in the pause time. The duration of the *feeding* can be set by P7, while the *pause* time can be set by P8.



When the welding is finished:

- First the *wire feeding* stops (if it works);
- Elapsing the wire burn back time (P1), the *welding current* ceases;
- Elapsing the gas post-flow time (P2), the *gas flow* stops, too.

The P6 potentiometer *on the PCB* sets the minimal wire speed, while the P5 sets the maximal one.

## 6. Maintenance

**All electrical repair's must be carried out by a Licensed Technician,**

**The machine must be disconnected from the electrical supply before any repairs are made to the machine.**

**If the fault of the equipment remains or is caused by an unknown reason, contact the service division!**

- **Torch:** During the welding work apply anti-adhesive fluid (silicon spray) to the *gas nozzle* to prevent melted droplets adhering to it. The *contact tip* is a consumable part to be changed regularly depending on its wear (burning, erosion). The *torch liner* should only be cleaned by compressed air.

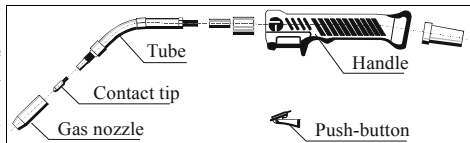

- **Cables and hoses:** Check *gas hose* and *input/output cables* for flaws, replace if necessary.
- **Wire feeder:** This must be checked and maintained regularly at the *drive roll* and the *guiding spiral*.
- **High-current unit:** *Remove* dust from inside the equipment using compressed air. *Check* and - if necessary - *tighten* screw at connections.

## 7. Trouble shooting

**All electrical repair's must be carried out by a Licensed Technician,**

**The machine must be disconnected from the electrical supply before any repairs are made to the machine.**

**If the fault of the equipment remains or is caused by an unknown reason, contact the service division!**

- **The green LED is off:** Faulty switch (Q1), mains cable or transformer(s); ⇒ replace it or contact the service.
- **Blown fuse:** ⇒ Find the *cause* of trouble (there may be short circuit in the machine!), replace fuse and *check* its rating.
- **The yellow LED is on:** The machine is overheated; ⇒ *wait* until the fan cools it down and the LED extinguishes.

- **No welding arc:** Faulty torch or its cable or button; ⇒ *replace* it. Loose connection at welding cables; ⇒ *fasten* it. Faulty control unit; ⇒ contact service.
- **Bad gas flow:** Empty gas bottle, faulty pressure regulator or flow meter, leakage at gas hose or gas valve; ⇒ repair or replace. The bottle or regulator is frozen, ⇒ *heat up* it by hot water or gas heater.
- **Irregular wire feed:** Worn or deformed input guide, roll or its groove, loose wire reel; ⇒ *locate fault* and repair it. Bad pressure on the roll; ⇒ set *correct* pressure. Faulty control unit; ⇒ contact service.
- **Bad quality of weld:** Bad gas flow, incorrect wire speed, contaminated surface, improper quality of wire or gas, bad welding parameters, worn parts of machine ⇒ use *good quality* products for welding, *maintain* the machine regularly.

It is very important that the welding parameters would be set *properly* for the welding task:

- **Welding current:** can be regulated by the wire feed speed, through the melting output.
- **Arc voltage:** weld with a *short* arc if it is possible; width, depth and surface of the seam depend also on this.
- **Sticking out:** it is recommended to be *short*; it influences the melting output, gas shielding, spatter loss.
- **Polarity:** the reverse polarity can be used *only* for piling welding.
- **Nozzle-to-work distance:** be *short* because of gas shielding, but the gas nozzle must be protected from *heat*.
- **Leading of the torch:** usually *pulling*; the *pushing* welding can be used for *root welding* because of the wide and flat seam.

## 8. Parts list

Nº	Part	qty	Code	Nº	Part	qty	Code	
<b>Mechanical parts</b>								
1.	Plastic handle	2	2142240230	2.	Fan holder Ø250	1	28422410	
3.	Fan blade Ø250	1	2142240175	4.	Safety grid for fan Ø250	1	2142240232	
5.	Cable fixing clamp	2	2342240567	6.	Wire reel holder	1	2142240076	
7.	Feeding mechan. 2445L-402D	1	2142241559	8.	Feeding roll Ø40/22, Ø0.9-1.2V	1	2342240737	
9.	Feeding roll Ø40/22, Ø0.6-0.8V	1	2342240647	10.	3/8" gas connector to cylinder	1	900000-117	
<b>Mains-voltage parts</b>								
11.	Mains cable 3×2.5 mm <sup>2</sup> , 5 m	1	2343630019	12.	Fuse holder PTF-35 (250V)	1	2343730015	
13.	Fuse B20/5.2, 1A	<i>FI</i>	2343730016	14.	Contacteur LC1-D32, 42V~	<i>KI</i>	2142320096	
15.	Filter unit EMC-2	1	28040622	16.	Fan motor VNT 16/25	<i>MI</i>	2142240583	
17.	Switch GN 25-6985 (0-3)	<i>QI</i>	2142330093	18.	Switch GN 25-8009 (1-7)	<i>Q2</i>	2142330092	
19.	Screw terminal K2.5B	1	2343730009	20.	Auxiliary transformer	<i>T2</i>	29081128	
<b>High-current parts</b>								
21.	Main transformer	<i>TI</i>	29081423	22.	Rectifier bridge CF-250R	<i>VI</i>	2142240234	
23.	Capacitor 10 mF 63V	<i>CI</i>	2344720411	24.	Resistor 27Ω 16W	<i>RI</i>	2344720323	
25.	Choke	<i>LI</i>	29090233	26.	Standard central adaptor	1	2142240095	
27.	Welding cable's socket CX-31	3	2142240068	28.	Welding cable's plug CX-21	2	2142240154	
29.	Earth cable 25 mm <sup>2</sup> , 5 m	1	2343630014	30.	Earth clamp 350A	1	2142240072	
<b>Low-voltage parts</b>								
31.	Fuse holder PTF-35 (250V)	1	2343730015	32.	Fuse B20/5.2, 3.15A	<i>F2</i>	2343730049	
33.	Gas solenoid valve 42V~	<i>YI</i>	2142241101	34.	Feed. motor D76L, 24V 45W	<i>M2</i>	2142241559	
35.	Electronic unit MHT 3.0	<i>AI</i>	2142241056	36.	11-pin PCB connector	1	2342240179	
37.	Turning knob FF-25	<i>(P4)</i>	2342240017	38.	Turning knob FF-16	<i>(K,P7,P8)</i>	3	2342240015

# Welding Tips

## Welding tips

The built-in main transformer of flat static characteristic provides *stable* welding even with *hand*-moved torch.

This means that e.g. the arc length increases (*shifting* work point), the arc voltage hardly changes but welding current and melting rate decrease: work point is *restored*.

### 1. Using gas

Properties of **argon** and **CO<sub>2</sub>** are in the next table. Properties of **mixed gas** are between the two so it is good *compromise* between quality and cost.

Property	Ar	CO <sub>2</sub>
Width of seam	wide	narrow
Height of seam	flat	big
Depth of penetration	small	deep
Dimensions of bath	big	small
Current of welding torch	low	big
Danger of contact tip burning	frequent	rare
Spatter	low	strong
Danger of porosity	-	middle
Weldability of structural steels	less	good
Pulse arc welding	excellent	not poss.
Dipping arc welding	adequate	excellent
Weldability of Cr-Ni steels	good (+O <sub>2</sub> )	condition-ally
Weldability of Al and alloys	possible	not poss.
Costs	very high	low

It can be seen that only un- or low alloyed steels are practical to weld with CO<sub>2</sub>.

It is worth considering offers of gas manufacturers!  
Flux-cored wire *doesn't* need any gas!

Typical values of *gas consumption* (litre/min):

wire Ø mm	gas cons.	wire Ø mm	gas cons.
0.8	8 – 12	1.2	10 – 15
1.0	10 – 12	1.4	12 – 16

### 2. Welding properties

Welding unalloyed **steel** (in case of butt joint, 82% Ar+18% CO<sub>2</sub> gas):

thickness	wire	current	voltage	w. speed
mm	Ømm	A	V	m/min
1.0	0.8	70	17	3.6
1.5	0.8	90	18	4.9
2.0	0.8	120	20	7.2
3.0	0.8	130	21	8.0
4.0	1.0	130	21	4.5
5.0	1.0	130	21	4.5
6 – 9	1.0	130 – 200	21 – 25	4.5 – 8.3
10 – 20	1.2	135 – 300	21 – 30	3.0 – 9.6

**Aluminium** and alloys (SG-AlSi5 wire and Ar gas):

thickness.	wire	current	voltage	w. speed
mm	Ømm	A	V	m/min
1.0	0.8	70	17	7.3
1.5	0.8	70	17	7.3
2 – 3	0.8	90	18	9.7
4.0	1.2	130	20	5.5
5.0	1.2	160	22	6.9
6.0	1.2	180	23	8.0

**Copper** and alloys (Ar gas):

thickness	wire	current	voltage	w. speed
mm	Ømm	A	V	m/min
3.0	0.8	175	23	10.9
5.0	1.2	210	25	6.0

### 3. Welding parameters

It is very important *welding parameters* properly to set to the welding process.

#### ◆ Welding current

Wire feed speed determines the welding current which assures uniform melting. Welding current is set by the wire feed speed.

#### ◆ Arc voltage

Too high: wider and longer weld, lower penetration depth, higher spatter and burning alloying elements - in turn good appearance of seam surface.

Too low: narrow and deep weld, poor appearance of seam surface, bulgy fillet weld.

#### ◆ Wire stickout

Too long: reduction of welding current (melting rate), bad gas shielding, strong spatter.

Too short: contact tip can be melted, and the wire can burn back.

Recommended values (according to welding current)

A	50	100	150	200	250	300	350	400
mm	5	6	8	10	12	14	17	20

#### ◆ Polarity

Unusual polarity can be used only for *piling* welding, but arc burns irregularly and spatter is stronger.

#### ◆ Gas nozzle-to-work distance

Too big: bad gas shielding.

Too small: difficult visible welding bath, easier melting gas nozzle, to which melted metal droplets can adhere.

Recommended value approx. 10-12 mm (15 mm upper 350 A).

#### ◆ Tipping torch

In the direction of travel (pulling): higher penetration depth, narrow and high seam; good gas shielding, well visible welding bath.

In the opposite (pushing): fusion defects, lower penetration depth, wide and flat seam (but good for thin plates and roots).

# Welding Tips



## Welding time diagrams

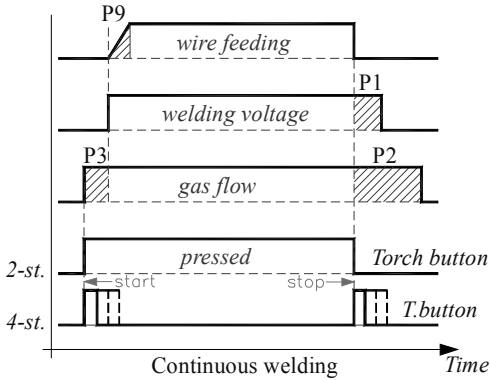

- ⊙ P3: Gas pre-flow time (0-0.5 s)
- ⊙ P9: Soft start time (0-0.2 s)
- ⊙ P1: Wire burn-back time (0-0.5 s)
- ⊙ P2: Gas post-flow time (0-2.5 s)

- ⊙ P7: Welding time (0.5-2.5 s)
- ⊙ P8: Pause time (0.5-2.5 s)

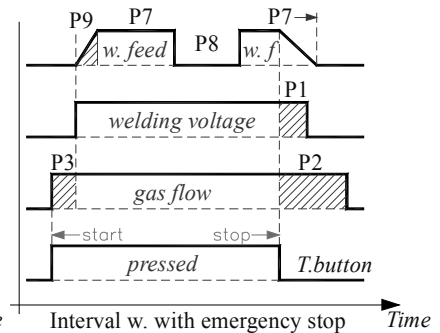
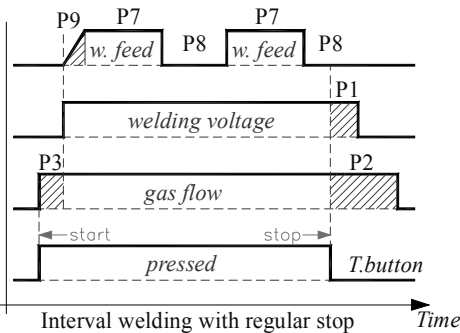
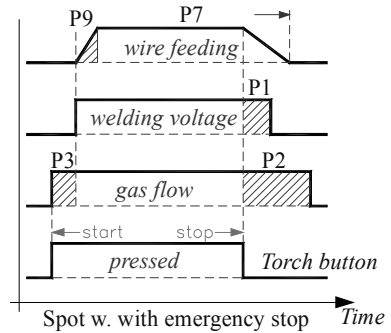
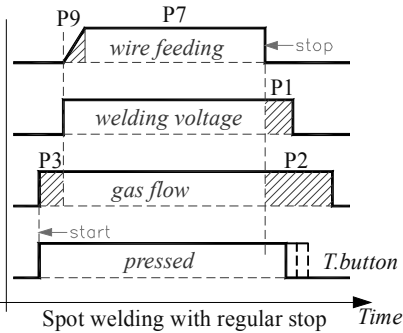



## MAINTENANCE

### WARNING:

Exposure to extremely dusty, damp, or corrosive air is damaging to the welding machine. In order to prevent any possible failure or fault of this welding equipment, clean the dust at regular intervals with clean and dry compressed air of required pressure.

Please note that: lack of maintenance can result in the cancellation of the guarantee; the guarantee of this welding equipment will be void if the machine has been modified, attempt to take apart the machine or open the factory-made sealing of the machine without the consent of an authorized representative of the manufacturer.

## TROUBLESHOOTING

### Caution:

Only qualified technicians are authorized to undertake the repair of this welding equipment. For your safety and to avoid Electrical Shock, please observe all safety notes and precautions detailed in this manual.

### WARRANTY

- 3 Years from date of purchase.

• Welding Guns of Australia Pty Ltd warranties all goods as specified by the manufacturer of those goods. This Warranty does not cover freight or goods that have been interfered with. All goods in question must be repaired by an authorised repair agent as appointed by this company. Warranty does not cover abuse, mis-use, accident, theft, general wear and tear. New product will not be supplied until

Welding Guns of Australia Pty Ltd has inspected product returned for warranty and agree's to replace product. Product will only be replaced if repair is impossible.  
If in doubt please ring.



**UNI-MIG**  
**WELDING**   
**WELDING GUNS OF AUSTRALIA Pty Ltd**

**WWW.UNIMIG.COM.AU**

### Disclaimer:

While the information is provided in good faith, Welding Guns Of Australia does not warrant the accuracy of information provided nor assume any legal responsibility for it or for any damage which may result from reliance on or use of it or from any negligence of Welding Guns Of Australia or other person/s with respect to it.

For further information please call Welding Guns of Australia Pty Ltd.

112 Christina Rd, Villawood NSW 2163 - PO Box 3033 Lansvale NSW 2166

UNIMIG pursue a policy of continuous research and development, and therefore reserve the right to change the specifications, or design, without prior notice. \* 3 year warranty power source.